

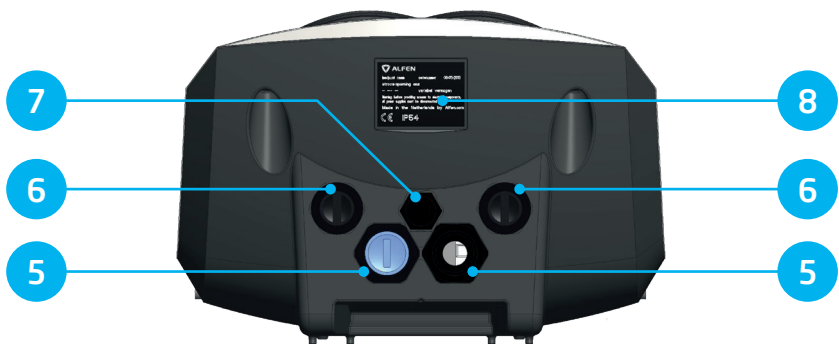

Eve Double Pro-line

Manual / Handboek / Handbuch / Manuel

OUTSIDE / BUITENZIJDJE / AUSSENSEITE / EXTÉRIEUR



INSIDE / BINNENZIJDE / INNENSEITE / INTÉRIEUR



Step-by-step Eve Double Pro-line installation and commissioning

Congratulations with your new Alfen charging station for electric vehicles, and thank you for your purchase.

To ensure a safe installation process and to fully utilise all advanced features of your new system, we advise you to read this manual carefully. Properly store this manual for future usage.

We have invested a great amount of care to provide you with a complete and comprehensible manual. As we continue to modify and further improve its contents, please refer to the following link to download the most recent version: <http://alfen.com>.

TABLE OF CONTENTS

1	Safety and usage instructions	7
1.1	Purpose and intended audience	7
1.2	General safety	7
1.3	Disclaimer	7
1.4	Copyright	7
2	Product	8
2.1	The charging station	8
2.2	User interface	9
2.2.1	Status indications on the display	9
2.2.2	Status indicator symbols	9
2.3	Operation	10
2.4	Eve Double Pro-line with single or double feeder cables	11
2.4.1	Eve Double Pro-line with single or double feeder cables overview	11
2.5	Access control for local authorisation (RFID)	12
2.5.1	Installing the master key	12
2.5.2	Adding and removing passes in the local database	12
2.5.3	Removing the Master Key	12
2.6	Technical specifications	13
2.6.1	Eve Double Pro-line model overview	13
2.6.2	Eve Double Pro-line specifications	13
2.6.3	General product specifications	13
2.6.4	Communication and protocols	14
2.6.5	Communication security	14
2.6.6	Available memory	14
2.6.7	User circumstances	15
2.6.8	Casing	15
2.6.9	Input / power supply	16
2.6.10	External protection according to EV/ZE-Ready	16
2.7	Optional factory settings	17
2.8	Accessories	17
3	Installing and connecting	18
3.1	Installing and connecting	18
3.2	mounting and installation requirements	19
3.3	Mechanical installation	19
3.3.1	Preparing the charging station	19
3.3.2	Wall mounting	19
3.3.3	Mounting post	20
3.4	Electrical installation	20
3.5	Maintenance	21
4	Commissioning the charging station	22
4.1	Safety instructions prior to usage	22
4.2	Commissioning	22
4.3	Configuring the charging station with the Service Installer (application)	22
4.3.1	Preparation	22
4.3.2	Using the Service Installer Application	23
4.3.3	Changing language settings	23
4.4	Activate functionality with the Service Installer application	23

5	Connectivity	24
5.1	Management systems	24
5.2	Setting up a connection	24
5.2.1	Wireless connection	24
5.2.2	UTP (Ethernet) connection	24
5.3	Registering your ICU EZ account	25
5.4	Managing settings	25
5.5	Registering your charging station within your own management system	25

Appendices

Appendix A: Error codes and problem solving	26
Appendix B: Default configuration of optional factory settings	29
Waste Electrical and Electronic Equipment (WEEE)	34

DECLARATION OF CONFORMITY

Manufacturer information:

Alfen ICU B.V.
Hefbrugweg 28
1332 AP Almere
The Netherlands

Declares the conformity of the product:

Charging stations of the type Alfen Eve Double Pro-line

Pursuant to European directives:

Low Voltage Directive 2014/35/EU
EMC Directive 2014/30/EU

Applied (harmonised standards)

- ÖVE/EN 61851-1
- NBN EN 61851-1
- NEN EN IEC 61851-1
- SFS-EN 6185
- NF EN IEC 61851-1
- DIN EN 61851-1
- BS EN 61851-1
- CEI EN 61851-1
- NEK-EN-6185 - 1

All mentioned products are labelled with the CE mark.

Almere, The Netherlands, 3 januari 2019



M. Roeleveld, Msc.

1. SAFETY AND USAGE INSTRUCTIONS

1.1 Purpose and intended audience

The Alfen Charge Point (the "Product") is intended exclusively for charging electric vehicles and, when installed correctly, may be used by untrained individuals.

Installation, commissioning and maintenance of this product may only be performed by a qualified electrician (Alfen-ICU certified partner). It is essential that the qualified technician has:

- Expertise on all relevant general and specific rules regarding safety and incident prevention
- Comprehensive knowledge of applicable electrical regulations.
- The ability to identify risks and avoid potential hazards.
- Received and read these installation and operation instructions

1.2 General safety



DANGER!

These safety instructions are important to ensure safe operation. Failure to comply with them in accordance with general electrical safety regulations could result in a risk of electrical shock, fire and/or life threatening injury.

Using this product is expressly prohibited in the following situations:

- In the vicinity of explosive or highly flammable substances.
- If the product is located in or close to water.
- If the product or its individual components are damaged.
- Usage by children or individuals not able to properly assess the risks associated with using this product.

Alfen ICU B.V. ("Alfen") shall not be liable in any way, for any kind of damage, and all warranties on both the product and accessories shall become void where:

- The ambient temperature is below -25°C or above 40°C.
- The Products have been subject to misuse, faulty installation or maintenance; or
- The Products have been disassembled, modified or repaired; or
- The manuals, operation and maintenance instructions which are applicable for (parts) of the Products or have been provided by Alfen are not complied with; or
- The Products are used in the vicinity of explosive or highly flammable substances or in or near to water; or
- In case of normal wear and tear; or
- There is a failure of the distribution network; or
- There is a force majeure situation, or the defect is otherwise caused from the outside.

More extensive safety information is available in the relevant sections of this document.

1.3 Disclaimer

This manual applies to the Product equipped with firmware version 4.7.0 or higher.

This document has been subjected to rigorous technical review before being published. It is revised at regular intervals, and any modifications and amendments are included in the subsequent issues. The content of this document has been compiled for information purposes only.

Although Alfen has made its best efforts to keep the document as precise and up-to-date as possible, Alfen shall not assume any liability for defects and damage which results from the use of the information contained herein.

In no event will Alfen B.V. be liable for direct, indirect, special or consequential damages (incl. loss of profits) resulting from any errors or omissions in this manual. All obligations of Alfen are stated in the relevant contractual agreements. Alfen reserves the right to revise this document from time to time.

Any deviation to the Products including, but not limited to, customer-specific modifications (like customisation by placing stickers, SIM cards or the usage of different colours), hereafter referred to as 'Customisation', can alter the final product experience, product appearance, product quality and/or product lifespan. Alfen is not liable for any damage to, or caused by, the product (including applied Customisation) if this damage is caused by this applied Customisation. Contact your dealer for more information on Customisation versus the default product.

1.4 Copyright

Copyright © Alfen N.V. 2020. All rights reserved. The disclosure, duplication, distribution and editing of this document, or utilization and communication of the content are not permitted, unless authorized in writing. All rights, including rights created by patent grant or registration of a utility model or a design, are reserved.

2. PRODUCT

2.1 The charging station

On pages 2 and 3 of this manual, you will find the images of the Eve Double Pro-line product line. In this chapter, you will find more information on the contents of the charging station and how it can be used to charge your vehicle.

The charging station

Outside

- ① Charging station identification number
- ② Colour display
- ③ RFID card reader and authorisation indicator
- ④ Type 2 plug connection
- ⑤ Cable gland(s) for power cable(s), entry
- ⑥ Grommets for outgoing cable(s)
- ⑦ Port for Service Installer/UTP cable
- ⑧ Identification label

Inside

- ⑨ Threaded holes for wall mounting
- ⑩ SIM card holder (ref. image 9 for detailed location)
- ⑪ UTP (Ethernet) connection

Bottom

- ⑫ Connector P1 port
- ⑬ Connector for display
- ⑭ On/off switch (4 pole) (model 904461022: 8-pole)
- ⑮ Ground wire terminal block (positioned under sockets)

Identification label

The identification label ⑧ found on the bottom of the charging station specifies elements such as:

- Model, production date and serial number.
- Technical specification number.
- Article number and maximum charging current.

When contacting Alfen, always have your serial number available to facilitate quick support.

2.2 User interface

The Eve Double Pro-line has a colour display which informs the user on the progress of the charging by using status indications.

2.2.1 Status indications on the display

General information on charging station

- ① The charge point ID: Identification is determined by the reseller or maintainer of the central management system. You can, for example, use this ID to convey to a helpdesk for which charging point you need support.
- ② Date and time: these are set through a maintenance system (automatically) or during installation, using the Service Installer Application. If the product does not have a current time, this field is invisible.

Status and information screen

The charging station informs the user of its current status and provides the user with a response to the actions performed. The following information is available:

- ③ Status information.
- ④ Status indicator (symbols)
- ⑤ Current charging capacity to the connected vehicle.
- ⑥ Maximum charging capacity of the outlet.
- ⑦ Energy picked up during the current transaction.
- ⑧ Duration of the current transaction.

Instruction field

- ⑨ Usage instructions will be displayed in this location. Where an error occurs, an error code and instruction will be shown (see Appendix A for more information).
- ⑩ Progress bar displays the progress of the authorization process in which (the) user is involved. A full progress bar indicates the necessary steps are completed and charging will start.

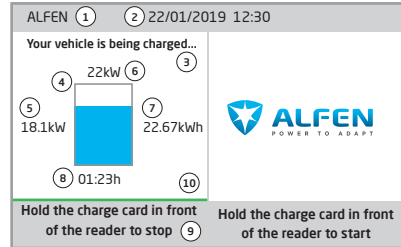

Figure 1a: Display of Eve Double Pro-line during charging with one socket

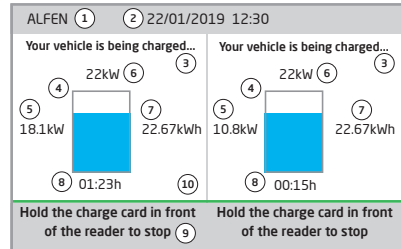

Figure 1b: Display of Eve Double Pro-line during charging with two sockets

2.2.2 Status indicator symbols



Charge card accepted, cable connected



Communicating with vehicle or charging complete



Warning, notification with error code

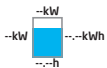

Charging transaction active, with charging speed indication



Error, notification with error code



Progress bar

2. PRODUCT

2.3 Operation

Specific user actions are presented in a sequence that clearly shows the progress and corresponding status indications. The first steps can be conducted in any sequence. Upon detecting a charging cable or charge card, all Eve Double Pro-line products will show a green status. The light blue (cyan) colour will only be displayed if and when a connection between the vehicle and charging station is established.

Start

Operation Plug & Charge - Authorisation without a charge pass



Pro-Line



Stop



Pro-Line



Start

RFID - Charging station with user authorisation



Pro-Line



Stop



Pro-Line



2.4 Eve Double Pro-line with single or double feeder cables

The international standard for conductive charging systems for electric vehicles is the IEC-61851-1. All charging equipment should be installed according to the IEC-61851-1 standard.

Installation Eve Double Pro-line with one feeder cable supplying two sockets.

A shared short circuit protection and overcurrent protection may be applied to the feeder cable in the installation.

The value of the protection per feeder cable must never exceed the output power of one outlet: A protection of 63A on one feeder cable while the maximum output power is 32A per socket is not allowed according to the IEC-61851-1 standard.

Installation Eve Double Pro-line with two feeder cables. Each feeder cable supplying one socket.

The maximum output power is 32A per socket. In accordance with the IEC-61851-1 standard a maximum protection of 32A is permitted for each feeder cable.



NOTICE!

During installation of two feeder cables there is an heightend risk of injury or hazards. Observe the installation instructions in the User Manual or Quick Installation Guide of the Eve Double Pro-line .

2.4.1 Eve Double Pro-line with single or double feeder cables overview

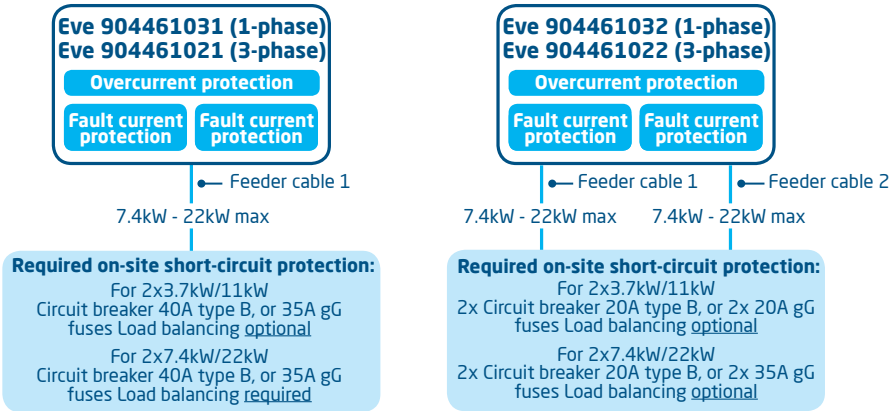

NOTICE!

Please refer to appendix B for smart charging options and settings.

2. PRODUCT

2.5 Access control for local authorisation (RFID)

To control local user access to an Alfen Eve Double Pro-line charging station, you need to install an RFID card as the 'Master key'. With this Master Key, you can determine who can use your charging station.

REMARK

Your charging station must be configured correctly in order to accept Master Keys. For stand-alone charge points this functionality is automatically ON. If the charging station is delivered with a pre-programmed management system, this functionality will be OFF.

2.5.1. Installing the Master Key

A Master Key can be easily installed using the following steps:

- ① Select an RFID card, like the included Alfen pass, that complies with the specifications mentioned in paragraph 2.6.2.
- ② Hold the RFID card in front of the card reader for 10 seconds. The charging station does not recognise the pass and will give a warning first. You can ignore this.
- ③ After 10 seconds, the RFID card will be registered as the Master key. The following icon appears on the screen:



! NOTICE!

The Master Key cannot be used for charging. It is only used for access control of the charging station.

The charging station will only recognise one RFID card as the Master Key.

2.5.2 Adding and removing passes in the local database

Once the Master Key is registered, it can be used to add or remove charging passes from the local database. For every pass held in front of the charging station, the station will give a sound signal. Follow the on-screen instructions to manage access control:

Hold the Master Key in front of the card reader

Hold the charge pass that you want to add in front of the card reader

Hold the charge pass that you want to remove in front of the card reader

Display



Supporting text on display

Master Key held in front of reader

Card added

Card removed

Add or remove charge passes

If you add or remove a charge pass in error, you can immediately hold it in front of the card reader to undo the action.

To close the database, hold the Master Key in front of the card reader once more.

REMARK

To prevent the local database from being 'open' to access control, the menu will close automatically if no card has been detected or removed after 10 seconds. The symbol will disappear from the display.

2.5.3 Removing the Master Key

A Master Key can only be removed using the Service Installer Application. If necessary, you can ask for help from one of our technicians. This might, however, incur costs. Therefore, always keep the Master Key in a safe location. More information on the use of the Service Installer Application can be found in paragraph 4.3.2.

2.6 Technical specifications

2.6.1 Eve Double Pro-line overview

Models

Model name	Article no.	OCPP chargePointModel
2 x type 2 socket, 1-phase, max. 1x32A input current, RCD B 3F 1C T2, Display	904461031	NG920-61011
2 x type 2 socket, 1-phase, max. 2x32A input current, RCD B 3F 1C T2, Display	904461032	NG920-61012
2 x type 2 socket, 3-phase, max. 1x32A input current, RCD B 3F 1C T2, Display	904461021	NG920-61001
2 x type 2 socket, 3-phase, max. 2x32A input current, RCD B 3F 1C T2, Display	904461022	NG920-61002

2.6.2 Eve Double Pro-line specifications

Operation	Plug & Charge authorisation RFID authorisation Central system Third-party apps
Display	7" TFT colour display, 800 x 480 pixels
Status indication	integrated on display
RFID card reader	RFID (NFC) ISO/IEC 14443A/B, MiFare Classic 13.56 MHz, DESFire Maximum length: 7 bytes
Access	Locations with restricted access Locations with non-restricted access

2.6.3 General product specifications

Number of outlets	• 2
Types of outlets	• Socket standard type 2, conform IEC62196-2 ed. 2
Supported power systems	TN-C, TN-C-S, TT, IT* * Caution: not all vehicles support the IT system. In that case, or with 3-phase charging, an isolation transformer is required.
Nominal output voltage (+/- 10%)	• 230VAC, 1-phase products • 400VAC (3x230VAC), 3-phase products
Maximum current per socket	• 32A per phase
Maximum current per socket	7.4kW, 1-phase products 22kW, 3-phase products
Connection clamps	Cable gland, clamping range for 147-25.5mm cable thickness Cable clamps on input filter block. Range: • 16mm ² per wire

2. PRODUCT

Main switch	4-pole pin, 80A, 400 VAC (904461031, 904461032, 904461021) 8-pole pin, 40A 400 VAC (904461022)
Activation relay	Integrated, simultaneous activation Extra safety relay in series
Overcurrent protection	Integrated in firmware; shut down 110% after 1200 seconds; 112% after 100 seconds; 120% after 10 seconds; 150% after 2 seconds.
Residual current protection	Type B 30 mA, per outlet
Available in- and outputs	RJ45 (Ethernet/LAN) RJ11 (active load balancing)
Load balancing	<ul style="list-style-type: none">• Optional• Mandatory for charging current greater than 16A per phase (Refer to the table in paragraph 2.6.9)

2.6.4 Communications and protocols

Controller	Central unit for charging currents and communication
Vehicle communication	Mode 3 in accordance with IEC 61851-1 ed. 3 (2017)
Internet/networking possibilities	Mobile network communication, Ethernet/LAN
Communication protocol Central System	OCPP 1.5 (JSON), OCPP 1.6 (JSON)
Supported RJ45 protocols	OCPP TCP/IP
Supported RJ11 protocols	DSMR 4.0-4.2 and SMR5.0 (P1 port) I/O for supporting external relay
Modbus (Master)	TCP/IP

2.6.5 Communications security

SIM card	Mini SIM card APN username and password
Central System authentication	TLS 1.2 x509 2048/4096 bit root certificate
EVSE authentication	HTTP Basic authentication, with or without TLS
Remote console access (SSH, telnet)	Not supported
Diagnostic files	Encryption: AES 128 bit
Firmware update files	Encrypted and digitally signed Encryption: SHA256 hash (pkcs1/PSS padding with 2048 RSA key) Signature: RSA public key 2048 bit
EVSE Internal Flash	AES 128 bit (erased when read)
Root certificate	Installed in the factory, update through UpdateFirmware file

For more information on the implementation of information security in Alfen Charging Equipment, you can contact cpadmin@alfen.com

2.6.6 Available memory

Charge passes	Local list: approx. 800 charge passes (via the Backend) White list: approx. 1,200 charge passes (local)
Transaction database	Approx. 1,500 transactions (of 4u with 15min Wh-metering values)
Logging for diagnostics	Approx. 45,000 lines

2.6.7 User circumstances

Operating temperature	-25°C - 40°C
Electrical safety class	I
Degree of protection (casing)	IP54
IK protection (mechanical impact)	IK10
Stand-by use	Ca. 9-12 W
Environmental conditions	Indoor use Outdoor use
Electromechanical environmental conditions	E2 according to the Measuring Instruments Directive (2014/32/EG)
Mechanical environmental conditions	M1 according to the Measuring Instruments Directive (2014/32/EG)

**NOTICE!**

The operating temperature assumes the ambient temperature of a product delivered in the default casing colour 'RAL9016'. Direct exposure to sunlight may have an adverse effect on the temperature range.

The ambient temperatures in the table above refer to a product in its default casing, colour RAL9016. Other (darker) colours may have an adverse effect on the product. If the product is exposed to lower or higher temperatures, continuous operation cannot be guaranteed. If temperatures exceed the maximum values, the charging station will automatically decrease the charging current to decrease the internal temperature.

This stabilises the internal temperature and makes it less likely that a transaction will be unexpectedly paused.

If the product is directly exposed to sunlight, the automated temperature management may automatically start below the maximum ambient temperature.

2.6.8 Casing

Type	Wall-mounted unit
Mounting options	Wall mounting or mounting post (accessory)
Material (cover)	Fibre-reinforced polyester (Sheet Moulding Compound - SMC)
Colour (cover)	RAL 9016 (Traffic white)
Material (rear)	Fibre-reinforced polyester (Sheet Moulding Compound - SMC)
Colour (rear)	RAL 7043 (Traffic grey B)
Locking	Anti-theft screws
Dimensions (H x W x D)	
Casing	590 x 338 x 230 mm
Product packaging	740 x 350 x 250 mm
Weight	
Casing	Approx. 15 kg
Complete, incl. packaging	Approx. 21,5 kg
Complete, incl. packaging and pallet	Approx. 25 kg

**NOTICE!**

Where products are exposed to the elements, the case can be subject to gradual aging of the material, which can result in product discolouration over time. Therefore, wherever possible, place the product in a sheltered place to optimise the life of the materials.

2. PRODUCT

2.6.9 Input / power supply



NOTICE!

Your installation must comply with the standards and regulations of the location (country) where it is located. The tables below are advisory and based on proper practical functioning of the charging stations; provided that all prerequisites are satisfied.

Printing errors expressly reserved

Input: minimum advised cable diameters (based on assumed max. 50m cable length)	1-phase	904461031	16A: 4 mm ²	32A: 6 mm ²
	1-phase	904461032	16A: 4 mm ²	32A: 6 mm ²
	3-phase	904461021	16A: 4 mm ²	32A: 6 mm ²
	3-phase	904461022	16A: 4 mm ²	32A: 6 mm ²

Short circuit protection	With Circuit Breakers:	With fuses:	Load balancing
Single power supply, 1-phase, 16A:	1 x 40 A max 1P, kar. B or C	1 x 35A max, gG	Optional
Single power supply, 1-phase, 32A:	1 x 40 A max 1P, kar. B or C	1 x 35A max, gG	Required
Double power supply, 1-phase, 16A:	2 x 20 A max, 1P, kar. B or C	2 x 20A max, gG	Optional
Double power supply, 1-phase, 32A:	2 x 40 A max 1P, kar. B or C	2 x 35A max, gG	Optional
Single power supply, 3-phase, 16A:	1 x 40 A max, 3P kar. B or C	3 x 35A max, gG	Optional
Single power supply, 3-phase, 32A:	1 x 40 A max, 3P kar. B or C	3 x 35A max, gG	Required
Double power supply, 3-phase, 16A:	2 x 20 A max, 3P kar. B or C	6 x 20A max, gG	Optional
Double power supply, 3-phase, 32A:	2 x 40 A max, 3P kar. B or C	6 x 35A max, gG	Optional

If you have opted for a capacity less than or equal to 16A (3.7 kW or 11 kW charging), 20A instead of 40A is sufficient.

Residual current protection	Residual-current circuit breaker (RCBB): min 100mA (S) Selective, 4P, A EV, or B
-----------------------------	--

Nominal voltage	<ul style="list-style-type: none">• L1-N: 230V (+/-10%)• L2-N: 230V (+/-10%)• L3-N: 230V (+/-10%)• L1-L2: 400V (+/-10%)• L1-L3: 400V (+/-10%)• L2-L3: 400V (+/-10%)• PE-N: ≈ 0V
-----------------	---

Nominal frequency	50 Hz/ 60 Hz
-------------------	--------------

Grounding	TN system: PE wire TT system: Independently installed ground electrode <100 Ohm spreading resistance IT system: connected to a shared reference (common earth) with other metal parts
-----------	---

Connection method	Permanently connected
-------------------	-----------------------

2.6.10 External protection according to EV/ZE-Ready

If EV/ZE ready compliance is required, only use RCCB's of type A+ (high immunity) or type B.

2.7 Optional factory settings

Description	Options
Authorisation	Plug & Charge RFID*
Maximum charging current	16A 32A*
Smart Charge options (see Appendix B)	Off Standard load balancing* Active load balancing* Smart Charging Network*
Own logo in display	Off (Alfen logo) On (your own logo)*
Languages supported	English, Dutch, German, French, Spanish, Portuguese, Italian, Norwegian, Swedish, Finnish
User availability if temporarily offline	Accept all RFID passes Only valid passes in database Not available
Action if plug is released on vehicle side	Stop transactions and release the plug Pause charging until cable plugged back in
Choice of management system	Stand alone ICU Connect* other options*
Communication through *	GPRS UTP/LAN Auto detect

* Settings may incur additional costs.
The default settings are always displayed first.







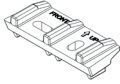

2.8 Accessoires

Mounting post	Art. 934459001
Dimensions (H x W x D)	1,430 x 180 x 80 mm
Material	SAE 304 stainless steel, Fine-structure powder coating
Colour	RAL 7043 (Traffic grey B)
Packaging (H x W x D)	1,460 x 360 x 280 mm
Weight	8 kg
Concrete pedestal	Art. 833829300-ICU
Dimensions (H x B x D)	570 x 350 x 220 mm
Weight	42 kg
Metal pedestal	Art. 803828601-ICU
Dimensions (H x B x D)	598 x 204 x 300
Weight	7.8 kg
Packaging (H x W x D)	50 x 295 x 620
Additional RFID card	Art. 203120010-ICU

3. INSTALLING AND CONNECTING

Package content

Content of the package of the charging station consists of: Alfen Eve™, installation manual, wall mounting block and assembly accessories, RFID charge cards (depending on the selected options)

1 x	1 x	1 x	2 x	1 x	1 x
					
Eve Double Pro-line	Wall-mounting frame	Allen key	Anti theft screw M8x20	This manual	Quick Installation Guide
4x	4 x	4 x	2 x		
					
Hex bolt M8x50	Washer	Nylon plug S10x50	Reduction fitting M32 x 1.5		

3.1 Installing and connecting

Carefully read these instructions prior to installing the charging station. Alfen ICU B.V. is not liable for any consequential damage caused by usage of this manual.

REMARK

The installation must be carried out by a qualified professional who has read this manual and works in compliance with IEC 60364 standards. Neglecting this may lead to severe injuries or hazardous situations while working with electricity.

REMARK

This work may not be carried out during rain or if air humidity exceeds 95%.

REMARK

A charging station must always be installed on a dedicated power circuit.

DANGER!

Hazard of fatal injury if installed incorrectly! Non-compliance with the installation and environment requirements may lead to hazardous situations while working with electricity.

REMARK

Protect Alfen products installed in public areas and car park sites from mechanical impact and/or collisions which can cause damage to the equipment.

DANGER!

The charging station contains electric components that may still contain electrical charge after being disconnected. Wait at least 10 seconds after disconnection before commencing work.

WARNING

The adaptors or conversion adaptors are not allowed to be used.

WARNING

Cord extension sets are not allowed to be used.

DANGER!

The electric system must be entirely disconnected from every power source prior to performing installation or maintenance work!

REMARK

The conditions at the specific location may influence the installation requirements.

REMARK

Protect Alfen products installed in public areas and car park sites from mechanical impact and/or collisions which can cause damage to the equipment.

3. INSTALLING AND CONNECTING

3.2 Mounting and installation requirements

Refer to the table in paragraph 2.6.9 and 2.6.10 to review the safety features and the required cable thicknesses to ensure a proper connection.

Ensure that the following requirements for installing the Alfen Eve Double Pro-line have been met:

- The cable trajectory from the main distribution station up to the Alfen Eve Double Pro-line must be protected against short-circuiting and over-current with:
 - B or C circuit breakers (or otherwise in compliance with local standards and regulations).
 - Type gG fuses (or otherwise in compliance with local standards and regulations).
- The cable trajectory and the charging station are part of a TN-S system; the station must be grounded via the main distributor.
- The cable trajectory must be installed in compliance with the usual locally applying professional standards.

REMARK

The installation and cables should be installed to match the maximum charging current to the input of the charging station. The diversity factor shall be taken as equal to 1, unless the maximum continuous current is limited by load control. The cable diameters stated in this manual are indicative. The installer is always responsible for choosing the right cable diameter and complying with the relevant standards and legislation.

While selecting a location to install the charging station the following criteria must be taken into account:

- Never install in a potentially explosive atmosphere.
- Never install in areas prone to flooding without implementing compensating measures.
- Always fully comply with local technical requirements and safety regulations.
- The installation site must have a levelled and solid underground.
- Maximum atmospheric humidity of 95%
- Ambient temperature of -25 °C to 40 °C.
- Temperature difference within 24 hours max. 35 °C.
- The recommended installation height is 70 to 120cm from the ground to the bottom side of the casing.
- Ensure that the charging station is located in such a way that the charging socket is easily reachable with the charging cable. The charging cable (approx. 5 metre length) must not be under tension while connected to the vehicle.
- Prevent road users from being able to drive over the cable.
- Prevent pedestrians from being able to trip over cables.
- Ensure that the UTP/Ethernet connection on the bottom side of the charging station is covered to prevent it from being unintentionally disconnected or used by unauthorised individuals.

3.3 Mechanical installation

3.3.1 Preparing the charging station

Do not remove the transparent foil from the casing during installation. This helps to prevent damage such as scratches on the display. Before installation, the white cover must be removed from the charging station. This is done as follows:

The front cover is firmly attached to the charging station and is secured with four screws at the top and bottom.

1. Lay the device on its back, preferably on a soft under ground such as the packaging of the Eve Double Pro-line.
2. Loosen the screws on the bottom with an Allen key.
3. Use a Torx m5 (T25) screwdriver to loosen the two screws on the side of the backside of the casing (ref. image 2).
4. Save these screws somewhere safe, they are required later.
5. Carefully lift the white cover, starting at the bottom in an upwards direction.
6. Take the entire white part of the unit and put it at a safe location where it cannot be scratched or damaged otherwise; for instance in the packaging of the Eve Double Pro-line. Be particularly careful with the display screen.

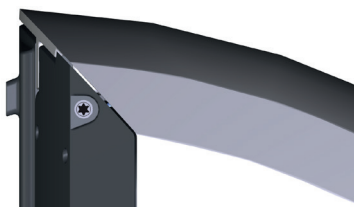

Image 2: Location of Torx T25 bolts to release, adjust and fasten the enclosure

3.3.2 Wall mounting

Use the following tools and equipment to install the Eve Double Pro-line :

- Spirit level
- Impact drill
- Phillips screwdriver
- Screwdriver for a terminal block
- Pencil
- Torx screwdriver (T25)
- Wire stripper
- Allen wrench
- 4 x M8 x 50mm hex bolts
- 4 x s10 x 50mm nylon plugs
- 4 x washers

3. INSTALLING AND CONNECTING

Installing the charging station

REMARK

Verify the indicated measures with a tape measure. The distances between the drill holes are 123.8 mm (top side), 39.6 mm (bottom site) and 434.3 mm (vertical).

1. Place the mounting block at the desired location.
2. Use a spirit level to level the mounting block.
3. Use the pencil to mark the drill holes.
4. Drill the holes at the marked points.
5. Verify the drill holes.

Installing the mounting block

1. Push fitting wall plugs into the four drill holes.
2. Attach the mounting block on the wall by using two screws in the two bottom drill holes.

Installing the charging station

1. Place the casing onto the already installed mounting block, in a vertical downward movement.
2. Use the pencil to mark the drill holes.
3. Drill the holes at the marked points.
4. Verify the drill holes.
5. Attach the casing on the top side with two screws at the right position (ref. image 3).

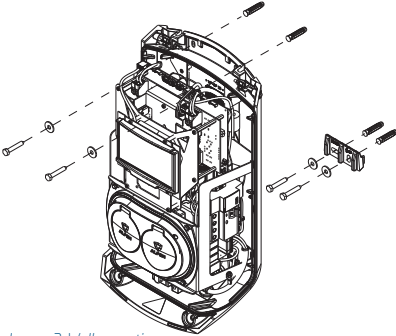

Image 3: Wall mounting

3.3.3 Mounting post: Install the post with the concrete pedestal or metal pedestal (accessory)

- 1x Groundwire (0,45 m)
- 1x Cable lug
- 4x Cros head bolt M8x30
- 4x Six-sided M10x25
- 4x Spring washer M10
- 4x Washer M10
- 1x Slotted head bolt M4x12
- Washer M4
- 1x bolt M8x20 Stainless A2 anti-theft
- 4 x Tap bolt M10x25

1. Dig a hole of approx. 50x50cm with a depth of 65cm.
2. Place the concrete or metal pedestal in this hole.
3. Attach the post on the pedestal with four threaded bolts M10x25 mm and the corresponding rings (ref. image on the cover or the pedestal's installation manual).
4. Attach the mounting block with two screw bolts M8x40 mm.
5. Attach the charging station on the post with two screw threads M8x40 mm.
6. Attach the ground wire on the post with M4x12 mm screw and an M4 washer.
7. Guide the ground wire through one of the glads into the charging station connect the ground wire to the terminal block (Pos. 15, page 3) and then mount the ground wire to the post under the appropriate bolt. (ref. image 4)
8. Attach the cover plate to the post with the anti-theft bolt M8 x 20 mm (ref. image 4).
9. Refill the hole in which the pedestal is placed and level the surface.
10. Once completed, cover the area with a levelled protection such as tiles.

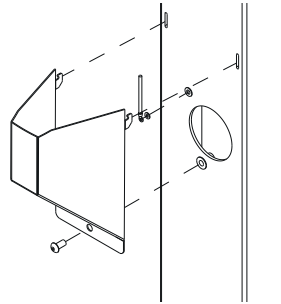

Image 4: Fixing the cable cover

3.4 Electrical installation



WARNING

Carefully read and follow all safety instructions in this manual!



DANGER!

The electric system must be completely disconnected from every power supply prior to carrying out installation and maintenance work!

1. Pull the power cable through the cable inlet, (Ⓢ on page 2).
2. Pull the power cable at least 15 cm into the housing

3. INSTALLING AND CONNECTING

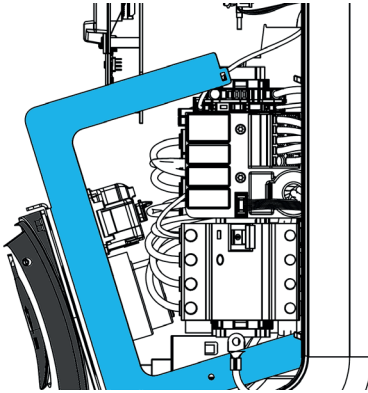

Image 5: Detachable subframe

3. Secure the power cable in the cable inlet by tightening it so that the power cable cannot be removed. The cable gland also functions as a strain relief.
4. The subframe with the type 2 charging sockets must be detached, refer to images 5 and 6. The subframe is equipped with a clicking mechanism on all four connection points. Detaching the subframe is best done by first detaching one side (left or right) followed by the other side.

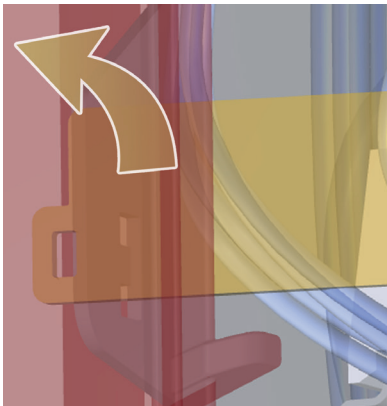

Image 6: Subframe clicking mechanism

5. Remove the sheathing from the cables with a wire stripper to connect the exposed wires in the main switch (13 on page 3).

6. Connect the wires to the isolating switch.
7. Place the subframe back in position by connecting the connection points with the rear frame.

! NOTICE!

Make sure the cables do not become trapped while putting the subframe back into place!

8. Verify that the residual current devices inside the charging station are enabled.
9. Put the isolating switch on the I (ON) position. If useful, use a special wrench to simplify switching.
10. Press the white part of the casing in the orifices on the top side of the rear cover.
11. Use a Torx T25 screwdriver to tighten the two screws on the top side of the unit (image 3).
12. Properly close the white part of the casing by pressing on it and screwing the M8 x20 anti-theft screws in the backside.

! NOTICE!

Absolutely no gaps may be present between individual parts of the casing. This is detrimental to moisture and dust protection, which has an adverse effect on the life-cycle of the charging station.

13. Now remove the transparent foil from the casing.

3.5 Maintenance

- Clean annually, preferably more often to prevent mildew or mold from getting into the surface, using water and a mild soap, or other non-aggressive cleaners.
- Apply surface wax after cleaning, e.g. car wax after cleaning. Before applying the wax (or coating), first degrease the surface (with an appropriate degreaser e.g. isopropanol). Always apply the wax layer with a clean soft (microfibre) cloth and rub off excess wax.

! WARNING!

Do not apply the isopropanol on the display.
Do not use a high pressure cleaner, no scouring sponges.
Do not use abrasives for cleaning.

- For the best result and a long product life renew the wax layer every year.

! WARNING!

Always first connect a proper ground conductor!

4 COMMISSIONING THE CHARGING STATION

REMARK

The Service Installer Application is available for download for Microsoft Windows on: www.alfen.com/en/downloads. 'EV charging points'. If you do not yet have an account to use the Service Installer Application, you can request one through <http://support.alfen.com> -> 'Configuration Tool' -> 'Sign up for an account'.

4.1 Safety instructions prior to usage

Ensure the following safety instructions are complied with prior to commissioning your charging station:

1. Ensure the charging station is properly connected to the power supply as described in this manual.
2. Ensure that the distribution of the electricity supply is separately protected by appropriate circuit breakers or fuses.
3. Ensure the charging station is installed in compliance with this manual.
4. Ensure that the casing always remains closed during normal use.
5. Ensure that the charging cable is not twisted and the cable, plug and casing are undamaged.

4.2 Commissioning

Switch on the power at the power cable. The charging station will now run a self-diagnostic. During this process, the following actions are performed:

1. The display briefly illuminates and then switches off.
2. The sockets are tested individually:
 - testing locking
 - testing internal relays, switching is audible
3. The display briefly illuminates.
4. The display switches on and shows the notification 'Charge point starting up'.
5. The start screen appears on the display, showing the logo.
6. The Alfen Eve Double Pro-line is now ready for use. If the charging station is configured to connect with an administration system, this will happen automatically and directly.
7. The charging station may be configured further if desired. Use the Service Installer software application to gain access.
8. Did you have your charging station configured with a smart charge feature? Then please verify its settings with the Service Installer to optimally configure the chargingstation for local requirements.
For more information, please refer to Appendix B.

4.3 Configuring the charging station with Service Installer Application

4.3.1 Preparation

Eve Double Pro-line charging stations are easily configured using the Service Installer Application. This application allows you to access many settings, view the factory settings and see all the completed transactions and recognised charge passes.

The version number of the Service Installer Application is connected with that of the firmware to show you which new functionalities are supported by your charging station.

Tip: Before installing the charging station, make sure you have a user account and are using the newest version of the Service Installer Application. You can request an account at: <http://support.alfen.com>. Click on 'Sign up for an account'. Note that new account creation may take several working days.

Connect the charging station to your laptop with an Ethernet cable (UTP).

4.3.2 Using the Service Installer Application

When you log in, you will see the charging station settings divided into different categories. In most cases, the charging station has already been configured according to preferences with few adjustments necessary. If you ordered the smart charge options (see Appendix B), check the settings and adjust them where necessary to optimally configure the charging station for its location.

The Service Installer Application is divided into the following categories:

	General charging stations settings and status information.		Settings on the user interface/display.
	Power settings to configure the charging station for the local grid.		Load balancing, all of the smart charging options and settings in one location.
	Authorisations: managing charge passes and methods for user authorisation.		Activity log of the charging station.
	Transaction information for historic and current transactions.		Live monitoring: Take a look at the status of the charging station.
	Connectivity settings e.g management system connection settings (see paragraph 4.3), mobile communication (GPRS) and local network settings.		Warnings: shown in a single overview for quick analysis.

Functionalities shown in grey were not specified when ordering and so the charging station does not support them.

4.3.3 Changing language settings

Alfen's charging station interface supports ten different languages.

Changing the language can be done in two ways:

1. Via the Service Installer Application; proceed from General Settings to 'Localisation'. Where, you can edit the language settings.
2. Via a connected management system; Go to the language settings screen on the management platform. Every Alfen charging station has the 'Language' setting item. The table below provides an overview of the languages supported.

Language	Country code	Language	Country code	Language	Country code	Language	Country code	Language	Country code
Dutch	n_NL	German	de_DE	Spanish	es_ES	Italian	it_IT	Swedish	sv_SE
English	en_GB	French	fr_FR	Portuguese	pt_PT	Norwegian	nn_NO	Finnish	fi_FI

4.4 Activate functionality with the Service Installer Application

The charging station is connected to Alfen through the Service Installer Application. When necessary, you can retrieve the last known settings. This makes it possible to go back to factory settings or to retrieve new settings.

Alfen charging stations offer the unique possibility to be upgraded with new functionalities, even if these did not yet exist when the station was purchased. Returning to factory settings or retrieving a new 'license' will be sufficient. If the option is then activated, you can use and install it as desired.

5 CONNECTIVITY

5.1 Management systems

Alfen charging stations are intelligent, and can communicate with a range of online third party management systems or our own, Alfen ICU EZ. All of these provide the opportunity to track users' energy consumption, control charging remotely and simplify charge point maintenance via remote access.

Each charging station is already configured to directly connect with the chosen management system at point of manufacture, with internet connection established via GPRS or a UTP (Ethernet) cable connection depending on the model and/or customer preference. Where a GPRS connection is available, and was specified, the charge point is usually supplied with the SIM card installed and will connect automatically once the product is powered on. If the SIM card holder (item. ⑩ on page 3) does not contain a SIM card, it will either be included in the package or can be back-ordered. If in doubt, please contact the reseller or provider.

or more information on the Alfen management system ICU EZ, visit: www.alfen.com/en/ev-charge-points/services

5.2 Setting up a connection

5.2.1 Wireless connection

To connect wirelessly, the charging station must be equipped with a SIM card suitable for GPRS. The correct settings must also be chosen to connect with the desired management system.

There are several (shortcuts) in the Service Installer to support this. These allow easy selection of the desired management system and related settings. Always check the signal strength after installation, using the Service Installer.

REMARK

Whether and which management system a charging station connects to is arranged by the company reselling the product. This includes the services offered via this system, which are outside the scope of delivery of Alfen.

Where Alfen ICU Connect online management system was specified when ordering, the Eve Double Pro-line will already have a SIM card installed and will connect automatically when the product is powered on. If you chose another management system when ordering, you might need to install the SIM card yourself. Figure 7 shows the location of the SIM cardholder.

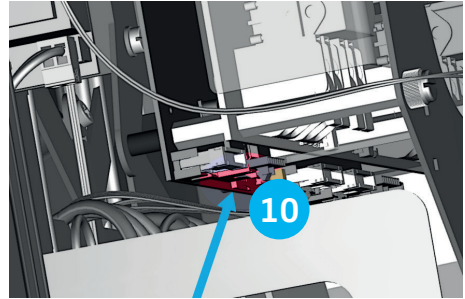

Image 7: Location of the SIM card holder.

5.2.2 UTP (Ethernet) connection

Which cable do you need?

A CAT5 UTP cable (max. 20 metres) is the minimum required to connect the charging station to the internet. This cable is suitable for speeds up to 100Mbps.

Installation

1. Connect the UTP cable to your router.
2. Make sure the charging station is turned off (de-energised) at the local installation.
3. Connect the UTP cable with the port on the bottom of the charging station (7) on page 2).
4. Connect the charging station as described in paragraph 3.4 and then turn on the power supply on the local installation.
5. In order for your charging station to communicate with ICU EZ via an UTP Ethernet connection, it may be necessary to change your network settings if these are additionally secured. The necessary information to obtain access through your network is:
 - IP address ICU EZ: 93.191.1.28.6
 - Port: 9090
 - FTP port: 21
 - Inbound - outbound

It might be necessary to add a MAC address. You can find this in the Network Settings tab in the Service Installer Application.

REMARK

Make sure your network settings allow connection to the Alfen servers through a secured FTP connection. This enables software updates and the exchange of diagnostics.

5.3 Register your ICU EZ account

If you want to enter into a contract for ICU EZ management services with Alfen, visit: www.alfen.com/en/services/management-charging-stations to register.

REMARK

You can only register as a user once you own the ICU EZ charging station. In order to register, you will need the information for your first charging station. We use this information to identify you. As soon as your account has been set up, Alfen will contact you with login details. Did you forget to register, but you have already ordered the ICU EZ? No problem. If you ordered the charging station to be configured to ICU EZ, your charging station is already registered and active in the management system. All transactions and other actions from the past are saved and visible to you.

1. Complete the registration form on the Alfen website.
2. In the 'remarks' field, enter the numbers located on the back of your charge passes.
3. Click 'Send'.
4. Alfen will process your request and activate your account. Your login details will be sent as soon as possible.
5. With these login details, you will be able to log in to the website www.alfen.com/en/more/login.
6. After logging in on ICU EZ, you will be able to access your charging station and its status immediately.

5.4 Managing settings

If your charging station is connected to a management system, it is possible to manage settings remotely even without using the Service Installer Application. Alfen charging stations offer a myriad of configuration possibilities, for everything from basic settings to advanced smart charge settings. These fall broadly into the following categories:

- General information, such as the present charging current and temperature
- General settings for the charging station like language, intensity of the status indications and load capacity
- Switching between RFID and Plug & Charge and
- Settings for transaction messages
- Smart charge settings
- Connectivity
- Smart Charging Network
- Overview of activated options (see paragraph 2.6) and possibility to change (license code)











Alfen innovates continuously. Settings are regularly added, extended, adjusted and removed. The latest version of all settings can always be found at: www.alfen.com/en/downloads

5.5 Register your charging station to your own management system









When using a non-Alfen management system, it is essential that you register the charging station model. The Eve Double Pro-line model will send a ChargePointModel in accordance with OCPP specifications when logging in. The table in paragraph 2.6.1 indicates available options.

APPENDIX A: ERROR CODES AND PROBLEM SOLVING

This appendix provides a description of, and advice related to, the error codes that can be generated by the Eve Double Pro-line charging station. If you are not able to find a working solution, please contact the seller of the charging station, or contact Alfen Support using the contact information displayed on the back of this manual.



Display		Troubleshooting		
Code	Error message text	Icon	Possible causes	Possible solutions
Generic				
001	Not able to charge. Please call for support.		Unknown generic error.	Contact the service department of your charge point supplier.
Error inside charge point				
101	One moment please. Your charging session will resume shortly.		DC fault current (>6mA) detected by charging station.	One specific vehicle: Contact your car dealership. Multiple vehicles: Contact the service department of your charge point supplier.
102	Not able to charge. Please call for support.		Internal error. Unexpected or no voltage on output of power board.	Contact the service department of your charge point supplier. • Check powerboard.
104	Not able to charge. Please call for support.		Internal error. Voltage to low on internal power supply (power board).	Contact the service department of your charge point supplier. • Check powerboard.
105	Not able to charge. Please call for support.		Internal error. No communication with internal power meter.	Contact the service department of your charge point supplier. • Check if internal power meter is connected correctly. • Check if internal power meter is configured correctly. • Check internal power meter.
106	Not able to charge. Please call for support.		Power interrupted by internal 30mA AC residual current protection device.	Contact your installation engineer. Internal RCD tripped.
Error in installation				
201	Error in installation. Please check installation or call for support.		Protective earth not connected or unstable.	Contact your installation engineer. • Recommended earth resistance of the installation < 100 Ohm.
202	Input voltage too low, not able to charge. Please call your installer.		Supply voltage below 210 VAC.	Contact your installation engineer.
206	Temporary set to unavailable. Contact CPO or try again later.		Charging station is set to inoperative by the Charge Point Operator / the charging station is updating.	Contact your charge point operator.
211	Not able to lock cable. Please call for support.		Unable to move locking motor during build-in self-test.	Contact your charge point operator. • Check if locking motor is connected correctly. • Check if locking motor can move.
212	Error in installation. Please check installation or call for support.		Missing phase in installation.	Contact your installation engineer. • Check voltage levels.

APPENDIX A: ERROR CODES AND PROBLEM SOLVING

Display		Troubleshooting						
Code	Error message text	Icon	Possible causes	Possible solutions				
Error in car								
301	One moment please your charging session will resume shortly.		Unknown error in communication with car.	<ul style="list-style-type: none"> Check car and charging cable. Otherwise contact the service department of your charge point supplier. 				
302	One moment please your charging session will resume shortly.		Safety measure, Vehicle draws more power than allowed / did not reduce power in time according to the IEC 61851 norm.	<table border="0"> <tr> <td>One specific vehicle:</td> <td>Contact your car dealership.</td> </tr> <tr> <td>All vehicles:</td> <td>Contact the service department of your charge point supplier.</td> </tr> </table>	One specific vehicle:	Contact your car dealership.	All vehicles:	Contact the service department of your charge point supplier.
One specific vehicle:	Contact your car dealership.							
All vehicles:	Contact the service department of your charge point supplier.							
303	One moment please your charging session will resume shortly.		Safety measure, charging is started too often within 1 minute.	<ul style="list-style-type: none"> Check car and charging cable. Otherwise contact the service department of your charge point supplier. 				
304	Charging not started yet to continue please reconnect cable.		Cable connected for more than 2 minutes without starting a charging session.	<ul style="list-style-type: none"> Reconnect cable and start charging session within 2 minutes. Otherwise contact the service department of your charge point supplier. 				
Error from outside (user, plug, cable, weather influences, etc.)								
401	Inside temperature high. Charging will resume shortly.		Temperature inside the charge point above 70 degrees Celsius.	<table border="0"> <tr> <td>Unexpected:</td> <td>Contact the service department of your charge point supplier.</td> </tr> <tr> <td>Expected:</td> <td>Contact your installation engineer.</td> </tr> </table> <ul style="list-style-type: none"> Ambient temperature. No EV charging. Ambient temperature. Installed in direct sunlight. EV charging. 	Unexpected:	Contact the service department of your charge point supplier.	Expected:	Contact your installation engineer.
Unexpected:	Contact the service department of your charge point supplier.							
Expected:	Contact your installation engineer.							
402	Inside temperature low. Charging will resume shortly.		Temperature inside the charge point below -40 degrees Celsius.	<table border="0"> <tr> <td>Unexpected ambient temperature:</td> <td>Contact the service department of your charge point supplier.</td> </tr> <tr> <td>Expected ambient temperature:</td> <td></td> </tr> </table> <ul style="list-style-type: none"> Contact the service department of your charge point supplier. 	Unexpected ambient temperature:	Contact the service department of your charge point supplier.	Expected ambient temperature:	
Unexpected ambient temperature:	Contact the service department of your charge point supplier.							
Expected ambient temperature:								
403	Charging not started yet to continue please reconnect cable.		Generic error.	Contact the service department of your charge point supplier.				
404	Not able to lock cable. Please reconnect cable.		Unable to lock the charging cable.	<ul style="list-style-type: none"> Contact the service department of your charge point supplier. Check socket and charging cable plug. Check if the lock motor can move freely. 				

APPENDIX A: ERROR CODES AND PROBLEM SOLVING

ENGLISH

Display		Troubleshooting			
Code	Error message text	Icon	Possible causes	Possible solutions	
Error from outside (user, plug, cable, weather influences, etc.)					
405	Cable not supported. Please try connecting your cable again.		Measure PP resistance of the charging cable is out of range according to the IEC 61851 norm.	One specific cable:	Cable broken
				<ul style="list-style-type: none"> Issues with other charge points. 	
406	No communication with vehicle. Please check your charging cable.		Monitored CP voltage level is out of range according to the IEC 61851 norm.	One specific cable:	Cable broken.
				<ul style="list-style-type: none"> Issues with other charge points. 	
				All cables:	Contact the service department of your charge point supplier.
				<ul style="list-style-type: none"> No issue with other charge point. 	

APPENDIX B: DEFAULT CONFIGURATION OF OPTIONAL FACTORY SETTINGS

The Eve Double Pro-line charging station has the following Smart Charge options:

1. Active load balancing: this offers the same functionality for managing charging speeds as the default load balancing in double charging stations. Managing the maximum charging current now, however, is a dynamic process. The charging station communicates with the smart meter in your installation or home and takes the current usage and maximal capacity of your grid connection into account.
2. Smart Charging Network (SCN): When activated, Alfen charging stations will recognise each other within a local network, a so-called charging plaza. In that case, the local grid settings are shared between the charging stations. Together, the charging stations decide how much power each outlet - provided a vehicle is connected - will be allocated. To simplify the order process of smart charge functionalities, a number of parameters have been provided with default settings. This appendix provides the values of these settings. If your installation needs different settings from these defaults, use the Service Installer to configure the charging station for your specific situation.

B.1. Active load balancing

Requirements for the installation:

- Alfen charging stations with activated Active Load balancing functionality.
- Communication cable with 4-wire RJ11/RJ12 connectors.
- Smart meter supporting one of the following protocols:
 - DSMR or eSMR over a P1 port. See paragraph 2.6.4. for the supported versions of this protocol.
 - Modbus TCP/IP: the charging station will assume the role of the Modbus Master in this configuration. The smart meter is the Slave.
- The charging station is also able to communicate with a customer's Energy Management System (EMS).
 - The communication protocol Modbus over TCP/IP is used to transfer data from the EMS to the charging station.
 - In this case the charging station acts as a 'slave' and the EMS as a 'master'.

The charging station and the smart meter communicate via the P1 port. For this, the DSMR protocol is used (for supported versions, see paragraph 2.6.4). Periodically, information on current usage is exchanged. When the meter capacity is reached, the charging station will adjust the connected vehicle. This prevents the installation from overloading, otherwise the cost of the grid connection will unnecessarily go up. This functionality effectively makes for 'peak shaving', it controls the power supply during peak moments.

If the P1 port of the smart meter is already occupied by another device, you can use a splitter. For advice on splitters, please contact your dealer.

NOTICE!

Not all splitters can be used. 2-wire connectors cannot be used. In that case, your charging station might not be able to communicate with the smart meter. Alfen is not liable for continuous and correct operation of the connection to the P1 meter if this has multiple devices and/or splitters attached.

To set up the active load balancing correctly, set the following parameters:

- Station-maxCurrent; This limits the maximum current on the charging station group.
- SmartMeter-maxCurrent; This is the capacity of your grid connection. When in doubt, check this with your grid operator.
- Load balancing safe current (A): the value of the current that remains available for the charging station (or charging plaza) when the connection between the energy meter and the charging station is lost.

NOTICE!

Alfen recommends a maximum cable length of 20 metres, combined with the P1 port. Always check if the communication with the smart meter is working properly. The quality of the signals depend on several factors. Therefore, always limit the cable length to prevent risks concerning the signal. Alfen ICU B.V. is not liable for continuous and correct operation of the connection to the P1 meter and the quality of the transferred signals.

APPENDIX B: DEFAULT CONFIGURATION OF OPTIONAL FACTORY SETTINGS

The table below provides the default settings for the parameters indicated:

Settings for maximum input current	At the outlet	Assumed settings	Active Load balancing on 1-phase connection	Active Load balancing on 3-phase connection
16A per phase	1 x 3.7kW	Station-MaxCurrent	16	16
	1 x 11kW	SmartMeter MaxCurrent	25	25
32A per phase	1 x 7.4kW	Station-MaxCurrent	32	32
	1 x 22kW	SmartMeter-MaxCurrent	40	35

If these values do not apply to your situation, have the installer adjust the settings using the Service Installer Application.

Modbus TCP/IP settings

In order for smooth communication with the smart meter through the Modbus TCP/IP, both need to be installed in the same network. Before reading out all necessary data fields, the smart meter and the charging station need to be able to communicate. For that, the following settings are important:

- Port: 502
- IPv4 addresses (use fixed IP address), assigned by the network operator
- Modbus address of the energy meter
- Default gateway of the local network
- Subnet mask of the local network

Factory settings	Options	Values
SCN-NetworkName	Name of the SCN	Maximum of 8 characters
SCN-SocketID	Unique ID of a socket within an SCN. For a charging station with two sockets, this identification represents socket 1.	0-255
SCN-SocketCount	The total amount of sockets in the SCN.	Maximum 100
SCN-AlternatingPeriod	The alternating period used in the event of insufficient capacity. This characteristic is automatically synchronised between charging stations within an SCN.	Maximum 65535 (seconds) Default: 360
SCN-TotalStaticCurrent	The maximum available capacity available for the SCN in amperes. This characteristic is automatically synchronised between charging stations within an SCN.	Default 200 A
SCN-SocketSafeCurrent	This safety value is used as a fall-back in case a charging station loses connection with the other stations. This characteristic is automatically syn-chronised between charging stations within an SCN.	Default 6.0 A
SCN-PhaseMapping-1	Single feeder cable on the left Socket: This characteristic shows how the charging station is connected to the installation (phase shifts). Attention! With double feeder cable: use SCN-Phasemapping-2.	Default: 4 1= L1, 2= L2, 3 = L3, 4= L1L2L3, 5= L1L3L2, 6= L2L1L3, 7= L2L3L1, 8 = L3L1L2, 9 = L3L2L1 Other values are invalid.
SCN-PhaseMapping-2	For single feeder cable on the Right Socket: This characteristic shows how the charging station is connected to the installation (phase shifts)	Default: 4 1= L1, 2= L2, 3 = L3, 4=L1L2L3, 5= L1L3L2, 6= L2L1L3, 7= L2L3L1, 8 = L3L1L2, 9 = L3L2L1 Other values are invalid.
SCN-TotalSafeCurrent	Used as a fall-back in case multiple charging stations loose connection with the other stations. The total number of active charging stations will be limited not to exceed the SCN-TotalSafeCurrent. This characteristic is automatically synchronised between charging stations within an SCN.	Default 32.0 A

APPENDIX B: DEFAULT SELECTIONS FOR OPTIONAL FACTORY SETTINGS

The table below provides an overview of values that can be read. Because the charging stations adjust to the currents per phase (bold in the table), this is the minimal information necessary to operate the active load balancing.

Measured value	Step size	Data type
Voltage L1L2 [V]	0.01 [V]	UNSIGNED32
Voltage L2L3 [V]	0.01 [V]	UNSIGNED32
Voltage L3L1 [V]	0.01 [V]	UNSIGNED32
Voltage L1N [V]	0.01 [V]	UNSIGNED32
Voltage L2N [V]	0.01 [V]	UNSIGNED32
Voltage L3N [V]	0.01 [V]	UNSIGNED32
Frequency [Hz]	0.001 [Hz]	UNSIGNED32
Current L1 [A]	0.001 [A]	UNSIGNED32
Current L2 [A]	0.001 [A]	UNSIGNED32
Current L3 [A]	0.001 [A]	UNSIGNED32
Current N [A]	0.001 [A]	UNSIGNED32
Active Power Sum [W]	0.1 [W]	SIGNED32
Reactive Power Sum [VAr]	0.1 [VAr]	SIGNED32
Apparent Power Sum [VA]	0.1 [VA]	UNSIGNED32
Cos(phi) Sum []	0.001 []	SIGNED32
Active Power L1 [W]	0.1 [W]	SIGNED32
Active Power L2 [W]	0.1 [W]	SIGNED32
Active Power L3 [W]	0.1 [W]	SIGNED32
Reactive Power L1 [VAr]	0.1 [VAr]	SIGNED32
Reactive Power L2 [VAr]	0.1 [VAr]	SIGNED32
Reactive Power L3 [VAr]	0.1 [VAr]	SIGNED32
Apparent Power L1 [VA]	0.1 [VA]	UNSIGNED32
Apparent Power L2 [VA]	0.1 [VA]	UNSIGNED32
Apparent Power L3 [VA]	0.1 [VA]	UNSIGNED32
Cos(phi) L1 []	0.001 []	SIGNED32
Cos(phi) L2 []	0.001 []	SIGNED32
Cos(phi) L3 []	0.001 []	SIGNED32

APPENDIX B: DEFAULT SELECTIONS FOR OPTIONAL FACTORY SETTINGS

B.2 Smart Charging Network

The Smart Charging Network (SCN) is the smart charging functionality that makes connected Alfen charging stations form a single charging plaza. For every outlet used, the network decides how fast it can charge, taking the total load into account. To achieve this, all connected charging stations exchange data on the current charging capacity for all users.

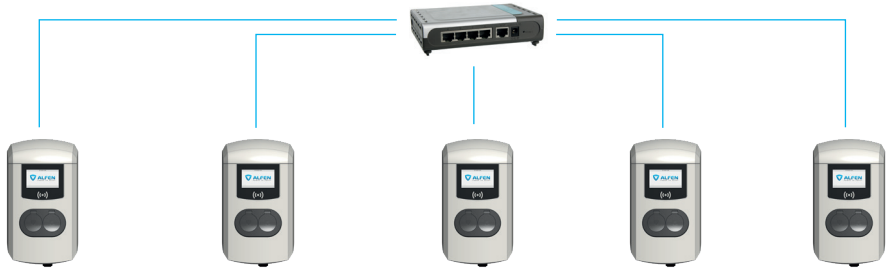

Figure 8: Smart Charging Network with Eve Double Pro-line models

To ensure the correct operation of an SCN, it is important that all settings are correctly configured. As soon as the communication for the charging stations is installed, the charging plaza will at least have the following settings:

- Total capacity for all charging stations combined.
- Maximum charging current per outlet: this is determined by the group in the local installation and the maximum charging current of the charging station.
- Minimum charging current per outlet; This setting is:
 - a security setting; when a charging station loses network connection, all charging stations will use this value. The charging station that lost connection will continue to charge on this minimal charging current while the other charging stations reserve this value, and will temporarily not utilize this.
 - Minimum speed as a preferred setting; as soon as an extra outlet is used for charging and the remaining capacity is not enough to supply the minimum, the outlets used will alternate; one will charge while the other pauses, in 15 minute intervals.
- Alternation period (pause) in the event of insufficient capacity; by default, this is 15 minutes. The administrator can change this, if desired.

Preconditions for a properly functioning Smart Charging Network:

- All charging stations are in the same network (subnet, IP range) By default, this is 169.254.x.x.
- CAT5 UTP/Ethernet cable (minimal), CAT6 for cable runs over 100m.
- Minimum 10Mbps network
- UDP port: 36549, inbound-outbound.
- Use the DHCP server, if possible.
- Without a DHCP server, the charging stations obtain an IP address via Auto-IP.
- All charging stations are fed from the same point, there is no layered electricity grid.

- An (existing) switch or router with a sufficient amount of connection points is available to connect all charging stations together.
 - Looping through from charging station to charging station is not possible.
 - Tip: Always make sure one port is available to connect a laptop with the Service Installer Application. Otherwise, make sure the laptop is in the same subnet as the charging stations.

REMARK

If network components like a switch or router are to be installed outdoors, we strongly advise purchasing the components accordingly and installing them in a suitable installation cabinet.

Adding a charging station to the Smart Charging Network

With the Service Installer Application, all charging stations in the Smart Charging Network will be set up at the same time. All charging stations within the same subnet will be identified by the Service Installer Application.

You can initialise the Smart Charging Network from the Service Installer. Select the charging station, navigate through the 'Device' menu to 'Add to new SCN'. Next, follow these steps:

- Name your SCN (charging plaza).
- Next, click on another charging station and click '+'. The charging station will be added to the desired SCN. The charging station will assume the network settings.
- Repeat step 2 until all charging stations are added to the SCN.

APPENDIX B: DEFAULT SELECTIONS FOR OPTIONAL FACTORY SETTINGS

If the functionality was purchased. The charging station will not be part of the SCN if you have not purchased this functionality. After you receive confirmation for your purchase of this functionality by Alfen, the new functionality can be downloaded using the Service Installer Application.



NOTICE!

After setting up a Smart Charging Network, all newly added charging stations will need to reboot. After rebooting, the charging stations will log in to the Smart Charging Network.

About OCPP

The functionalities of the SCN are available through the UTP/Ethernet connection of the charging stations. This can easily be combined with communication over OCPP, through UTP/Ethernet or GPRS. Note that you need one SIM card per charging station. To limit costs, you can also use a router and a (2G/3G/4G) modem. In that case, the charging stations should be set to communicate with a wired network. The router is then set for the (secure) APN of the relevant management system.

How to set up

Network choice	Per charging station	OCPP settings
Smart Charging Network with OCPP GPRS	SCN ON	OCPP Management System Selection for GPRS
Smart Charging Network with OCPP GPRS	SCN ON	OCPP Management System selection for UTP
Smart Charging Network with OCPP through external GPRS router	SCN ON	OCPP Management System selection for UTP
Electrical supply (local installation)	See paragraphs 2.5.11 and 2.5.12, always set to full power per charging station.	
Settings	Factory settings: set for charging station (max output)	

REMARK

Want to know more about the Smart Charging Network? Contact our Sales department or Sales Support via cpadmin@alfen.com

WASTE ELECTRICAL AND ELECTRONIC EQUIPMENT (WEEE)

Electrical and electronic equipment (EEE) contains materials, components and substances that may be hazardous and present a risk to human health and the environment when waste electrical and electronic equipment (WEEE) is not handled correctly. Equipment marked with the below crossed-out wheeled bin is electrical and electronic equipment.

The crossed-out wheeled bin symbol indicates that waste electrical and electronic equipment should not be discarded together with unseparated household waste, but must be collected separately.

For this purpose all local authorities have established collection schemes under which residents can dispose waste electrical and electronic equipment at a recycling centre or other collection points, or WEEE will be collected directly from households. More detailed information is available from the technical administration of the relevant local authority.

Users of electrical and electronic equipment must not discard WEEE together with household waste. Residents must use the municipal collection schemes to reduce adverse environmental impacts in connection with disposal of waste electrical and electronic equipment and to increase opportunities for reuse, recycling and recovery of waste electrical and electronic equipment.



Contact / Contact / Kontakt/ Contact

Alfen ICU B.V.
Hefbrugweg 28
1332 AP Almere
The Netherlands

P.O. box 1042
1300 BA Almere
The Netherlands

Tel. Sales Support: +31 (0)36 54 93 402
Tel. Service: +31 (0)36 54 93 401
Website: www.alfen.com/en/ev-charge-points

Art.nr: 203130037-ICU

